

Space

# Fair Jet Plus

**Article no.:** 7651900  
**Finish:** Chrome  
**Series:** Space

**EAN no.:** 5708516739920



## Standard features:

Water consumption max.9 l/min  
1500 mm plastic hose  
Incl. Soap dish & Glider

## Product features

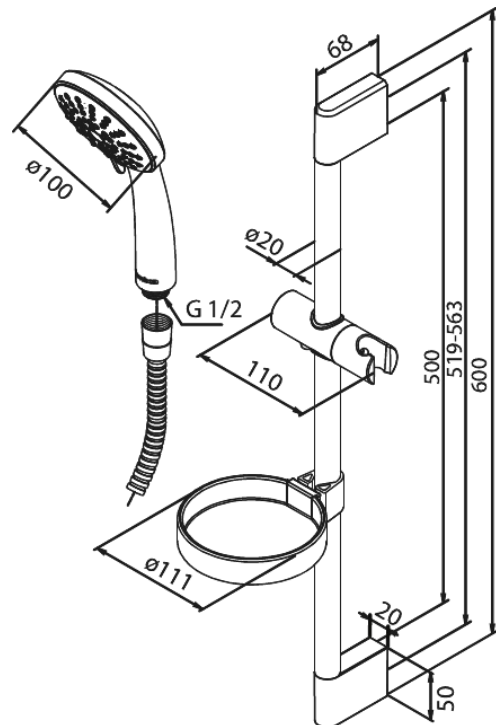

FM Mattsson Mora Group Denmark  
Hvidkærvej 48, 5250 Odense SV, DK-56416218

+45 88 33 00 34 [damixa-international@fmm-mora.com](mailto:damixa-international@fmm-mora.com)

Mere information på [damixa.com](http://damixa.com)

**damixa**